

MED7P7 is an AlInGaP red point source LED chip having a small emitting aperture. It is designed for optical communications over Plastic Optical Fiber (POF) and is also well suited for applications where small visible light is required, such as sensing and positioning.

Features

- Red light emission (λ_p :650nm)
- Small emitting aperture ($\phi 80\mu\text{m}$)
- High speed (f_c : 45MHz)
- High reliability

Structure

- Material : AlInGaP/GaAs sub.
- Electrode: Au alloy (p,n)
- Emitting surface: p-side

Applications

- POF communications
- Optical sensors etc.

Dimensional outline drawing(μm)

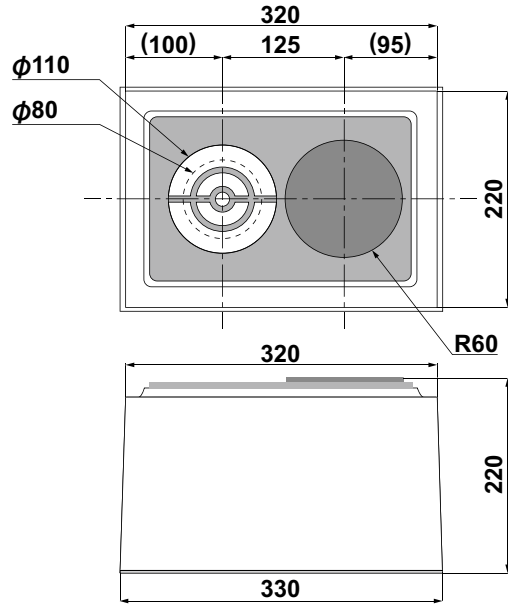

Absolute Maximum Ratings* ($T_a=25^\circ\text{C}$)

Parameter	Symbol	Rating	Unit
Power Dissipation	P_D	65	mW
Forward Current	I_F	25	mA
Reverse Voltage	V_R	3	V
Operation Temperature	T_{opr}	-40~85	$^\circ\text{C}$
Storage Temperature	T_{stg}	-40~100	$^\circ\text{C}$

Electro-Optical Characteristics* ($T_a=25^\circ\text{C}$)

Parameter	Symbol	Condition	Min.	Typ.	Max.	Unit
Forward Voltage	V_F	$I_F=20\text{mA}$	-	2.4	3.0	V
Reverse Current	I_R	$V_R=3\text{V}$	-	-	10	μA
Output Power	P_o	$I_F=20\text{mA}$	0.4	0.9	-	mW
Peak Wavelength	λ_P	$I_F=20\text{mA}$	630	650	670	nm
Cutoff Frequency	f_c	$I_F=20\text{mA}+10\text{mAp-p}$	-	45	-	MHz

*As mounted on T018 header and hermetically sealed

Fig1. I_F / T_a

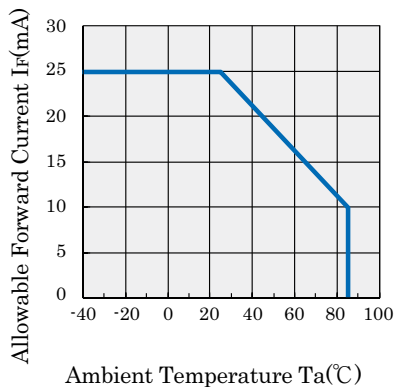

Fig2. I_F / V_F

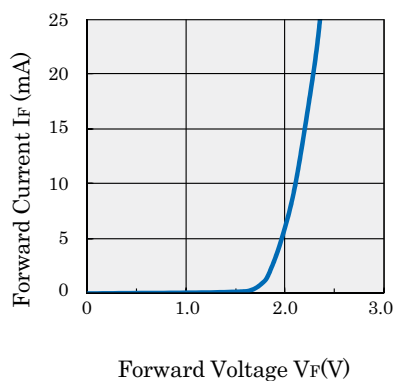

Fig3. V_F / T_a

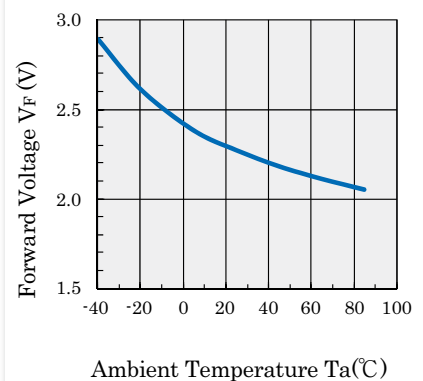

Fig4. P_O / I_F

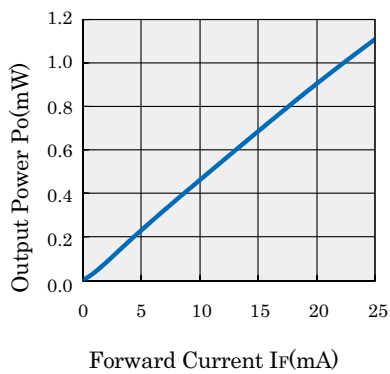

Fig5. Relative P_O / T_a

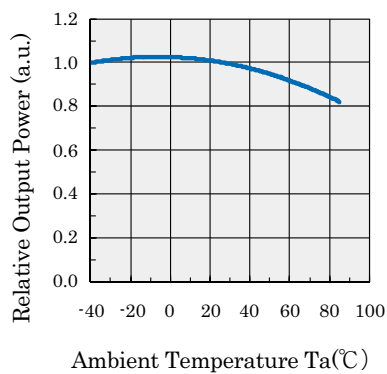

Fig6. Frequency Response

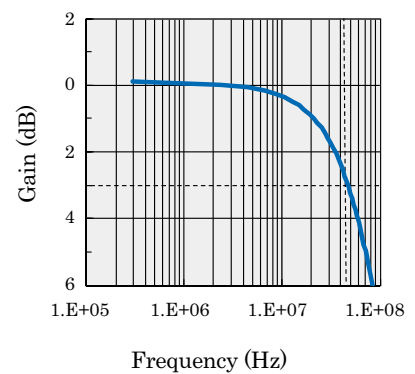

Fig7. Spectral Characteristics

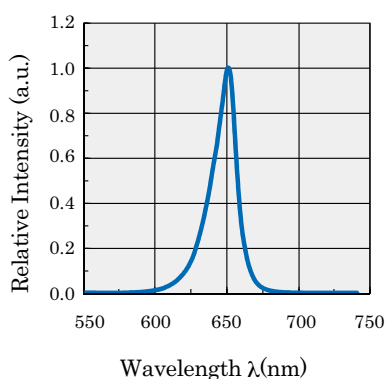

Fig8. Peak Wavelength λ_p / T_a

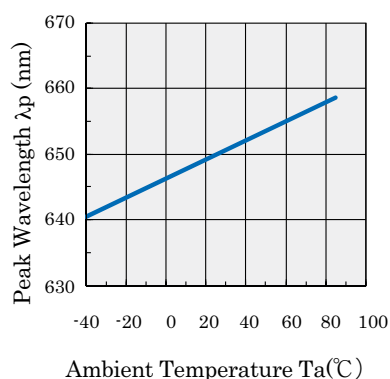
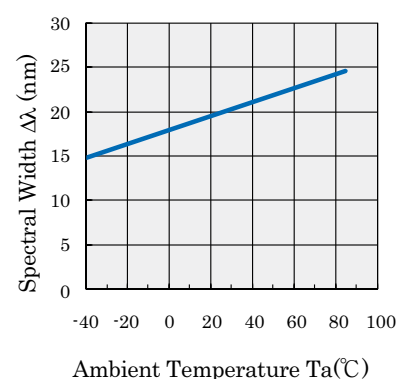

Fig9. Spectral Width $\Delta\lambda / T_a$



This catalogue was compiled in October 2012. All items listed in the catalogue are subject to change without any prior notice.

Products listed in this catalogue are manufactured for use in standard applications (eg: household appliances, OA/AV, telecommunications, measurement instruments). Please do not use the products in critical reliability and security applications (eg: space and aviation, critical-safety transport applications, nuclear power control, medical, life-supporting units and equipment).