

MED8P56A is a low failure infrared point source LED chip. It is well suited for optical switches, positioning and sensing applications due to its small-size emitting aperture.

### Features

- Small-size emitting aperture ( $\phi 150\mu\text{m}$ )
- Small side emission
- High output power
- High reliability

### Structure

- Material: AlGaAs/GaAs sub.
- Electrode: Au alloy (p,n)
- Emitting surface: p-side

### Applications

- Optical encoders
- Optical switches
- Optical sensors etc

### Dimensional outline drawing ( $\mu\text{m}$ )

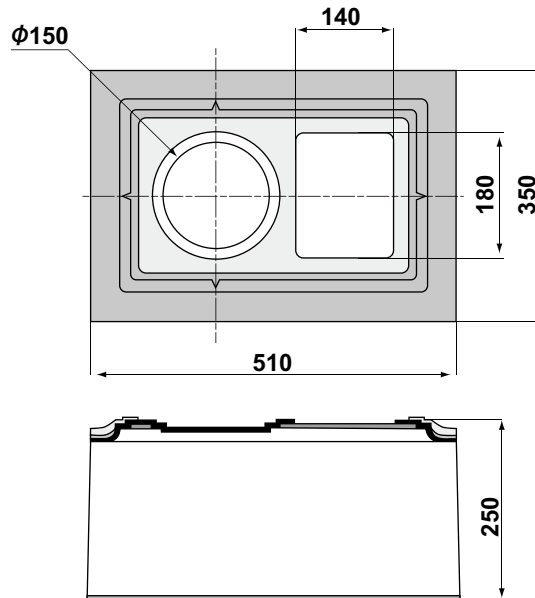

### Absolute Maximum Ratings\* ( $T_a=25^\circ\text{C}$ )

Parameter	Symbol	Rating	Unit
Power Dissipation	$P_D$	200	mW
Forward Current	$I_F$	100	mA
Reverse Voltage	$V_R$	3	V
Operating Temperature	$T_{opr}$	-20~80	$^\circ\text{C}$
Storage Temperature	$T_{stg}$	-30~100	$^\circ\text{C}$

### Electro-Optical Characteristics\* ( $T_a=25^\circ\text{C}$ )

Parameter	Symbol	Condition	Min.	Typ.	Max.	Unit
Forward Voltage	$V_F$	$I_F=50\text{mA}$	-	1.7	2.2	V
Reverse Current	$I_R$	$V_R=3\text{V}$	-	-	10	$\mu\text{A}$
Output Power	$P_o$	$I_F=50\text{mA}$	1.5	2.4	-	mW
Central Emission Wavelength	$\lambda_c$	$I_F=50\text{mA}$	-	855	-	nm
Side emission ratio	$R_s$	$I_F=50\text{mA}$	-	-	1	%

\*As mounted on T018 header and hermetically sealed

Fig1.  $I_F / T_a$

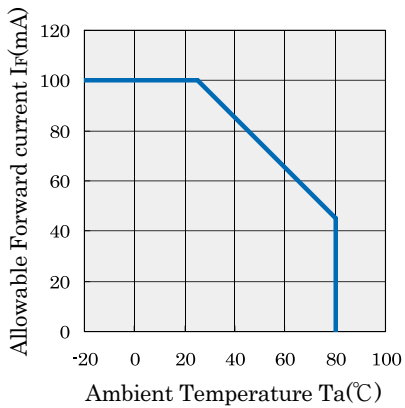

Fig2.  $I_F / V_F$

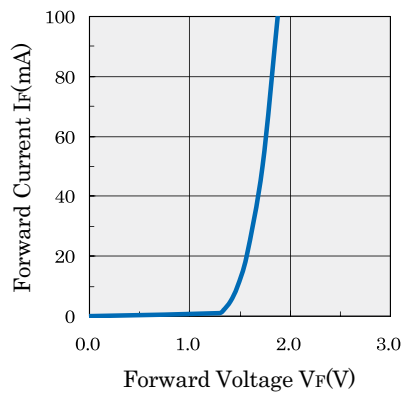

Fig3.  $V_F / T_a$

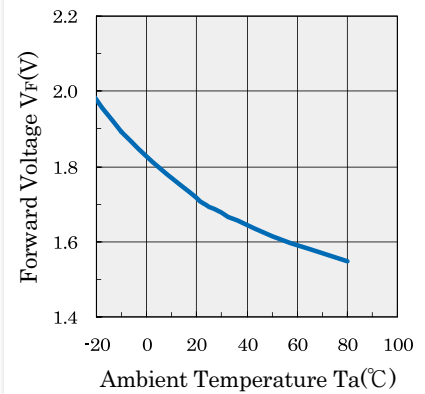

Fig4.  $P_O / I_F$

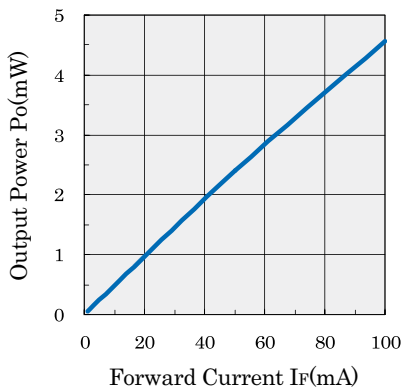

Fig5. Relative  $P_O / T_a$

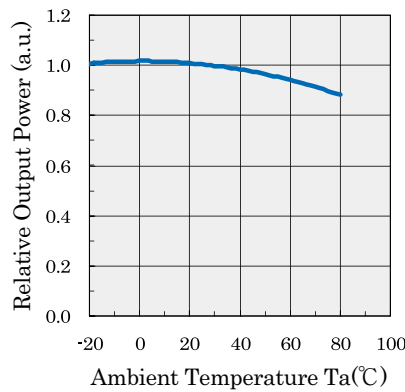

Fig6. Spatial Distribution

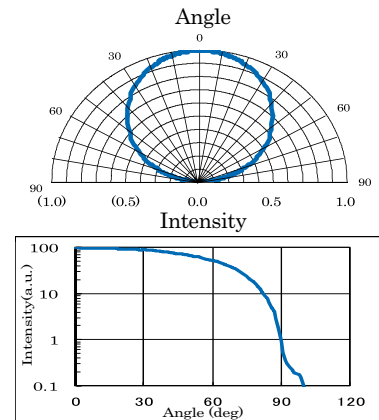

Fig7. Spectral Characteristics

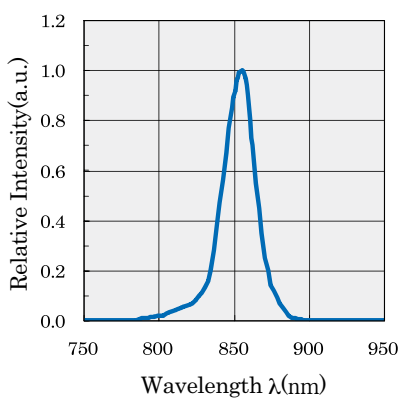

Fig8. Central Wavelength  $\lambda_c / T_a$

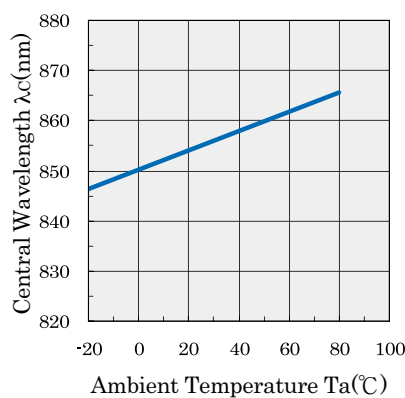
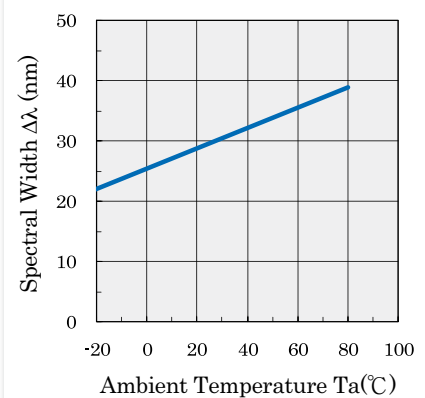

Fig9. Spectral Width  $\Delta\lambda / T_a$



This catalogue was compiled in October 2012. All items listed in the catalogue are subject to change without any prior notice.

Products listed in this catalogue are manufactured for use in standard applications (eg: household appliances, OA/AV, telecommunications, measurement instruments). Please do not use the products in critical reliability and security applications (eg: space and aviation, critical-safety transport applications, nuclear power control, medical, life-supporting units and equipment).