

MED8P64SA is a low failure rate infrared point source LED chip with resin guide for alignment lens or fiber. It is optimized for optical switches, encoders and other light source applications.

### Features

- Resin guide
- Small-size emitting aperture ( $\phi 100\mu\text{m}$ )
- High output power
- High reliability

### Structure

- Material: AlGaAs/GaAs sub.
- Electrode: Au alloy (p,n)
- Emitting surface: p side

### Applications

- Optical encoders
- Optical switches
- Optical sensors etc

### Dimensional outline drawing( $\mu\text{m}$ )

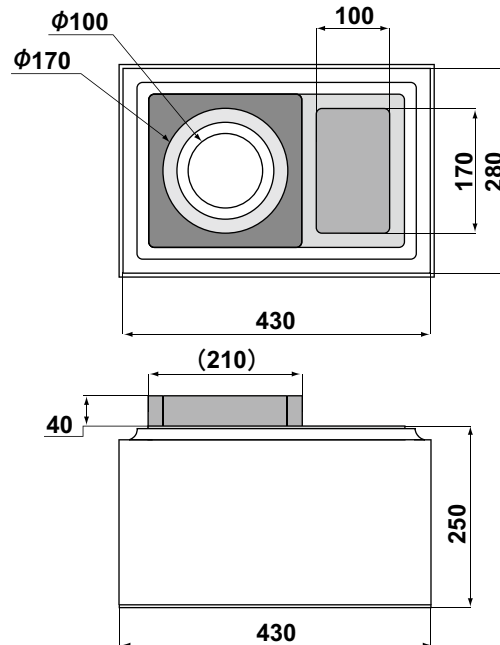

### Absolute Maximum Ratings\* ( $T_a=25^\circ\text{C}$ )

Parameter	Symbol	Rating	Unit
Power Dissipation	$P_D$	150	mW
Forward Current	$I_F$	80	mA
Reverse Voltage	$V_R$	3	V
Operating Temperature	$T_{opr}$	-20~80	$^\circ\text{C}$
Storage Temperature	$T_{stg}$	-30~100	$^\circ\text{C}$

### Electro-Optical Characteristics\* ( $T_a=25^\circ\text{C}$ )

Parameter	Symbol	Condition	Min.	Typ.	Max.	Unit
Forward Voltage	$V_F$	$I_F=50\text{mA}$	-	2.0	3.0	V
Reverse Current	$I_R$	$V_R=3\text{V}$	-	-	10	$\mu\text{A}$
Output Power	$P_o$	$I_F=50\text{mA}$	1.2	2.0	-	mW
Central Emission Wavelength	$\lambda_c$	$I_F=50\text{mA}$	-	855	-	nm
Cutoff Frequency	$f_c$	$I_F=50\text{mA}+20\text{mA p-p}$	-	25	-	MHz

\*As mounted on T018 header and hermetically sealed

Fig1.  $I_F / T_a$

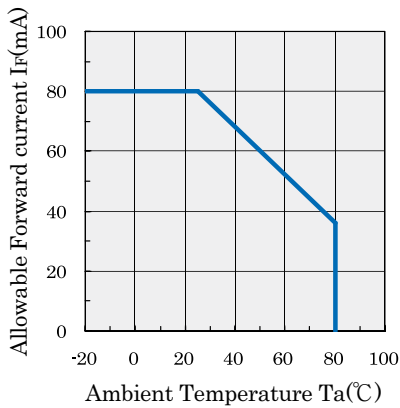

Fig2.  $I_F / V_F$

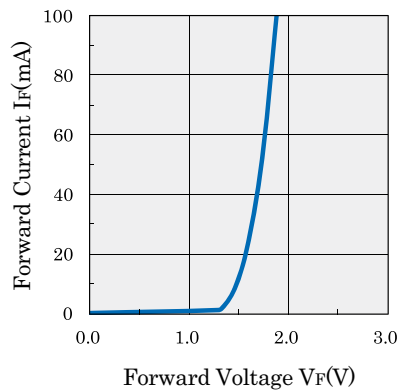

Fig3.  $V_F / T_a$

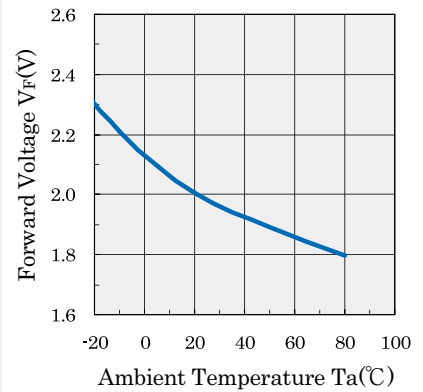

Fig4.  $P_O / I_F$

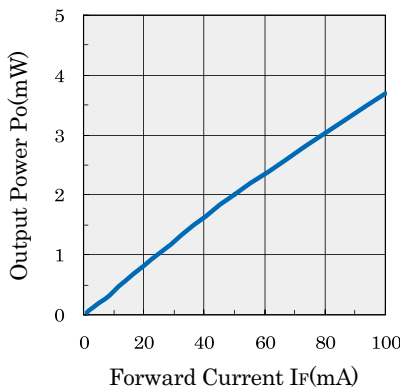

Fig5. Relative  $P_O / T_a$

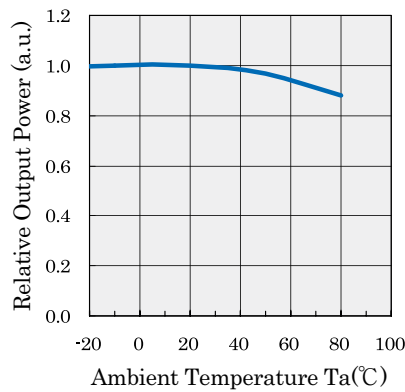

Fig6. Frequency Response

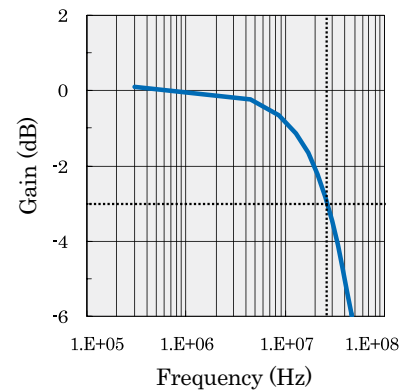

Fig7. Spectral Characteristics

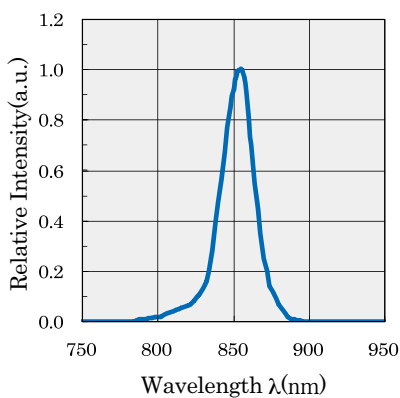

Fig8. Central Wavelength  $\lambda_c / T_a$

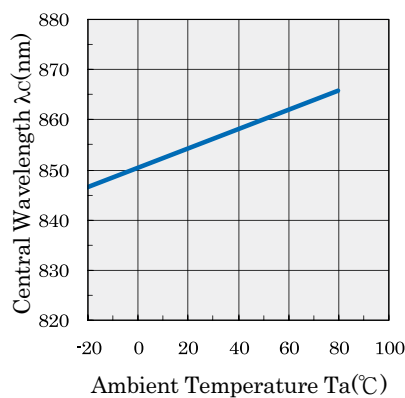
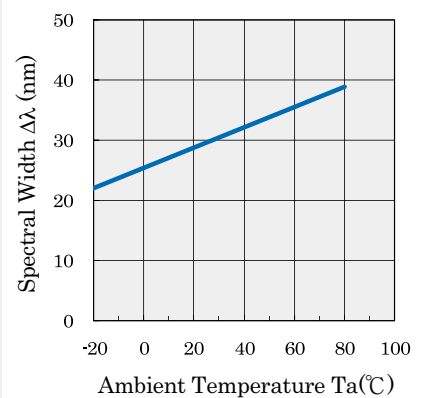

Fig9. Spectral Width  $\Delta\lambda / T_a$



This catalogue was compiled in October 2012. All items listed in the catalogue are subject to change without any prior notice.

Products listed in this catalogue are manufactured for use in standard applications (eg: household appliances, OA/AV, telecommunications, measurement instruments). Please do not use the products in critical reliability and security applications (eg: space and aviation, critical-safety transport applications, nuclear power control, medical, life-supporting units and equipment).